

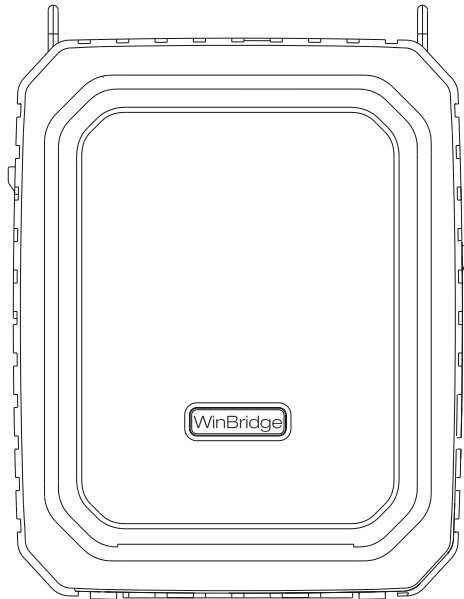

WinBridge

Natural Voice

Voice Amplifier User Manual



M800

Function Illustration

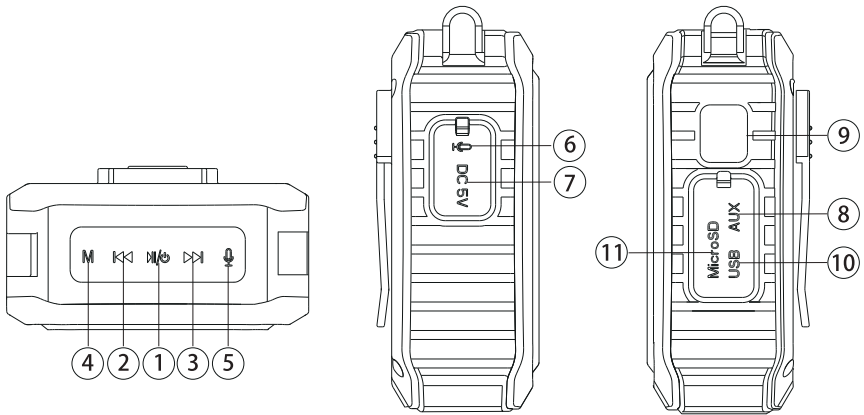

① Power switch / play & pause:

A: Press the button for 3 seconds to turn on/off.

B: In music playing mode, short press it to pause, short press it again to play.

② Previous/Volume-:

In music playing mode, short press for previous, long press for volume-.

③ Next/Volume+:

In music playing mode, short press for next, long press for volume+.

④ Mode Key:

Short M button to switch mode among Bluetooth, USB driver, TF card, AUX.

- ⑤ **Recording**
 - ⑥ **MIC slot**
 - ⑦ **DC 5V charging port**
 - ⑧ **AUX input**
 - ⑨ **LED screen** (Only displays the battery level.)
 - ⑩ **USB flash disk slot**
- A: to insert and play USB flash disk.
B: to work as a power bank.
- ⑪ **TF card slot**

Operation Description

1. Plug and play

Turn on speaker with power switch and plug the wired headset microphone included into MIC slot, then your voice will be amplified.

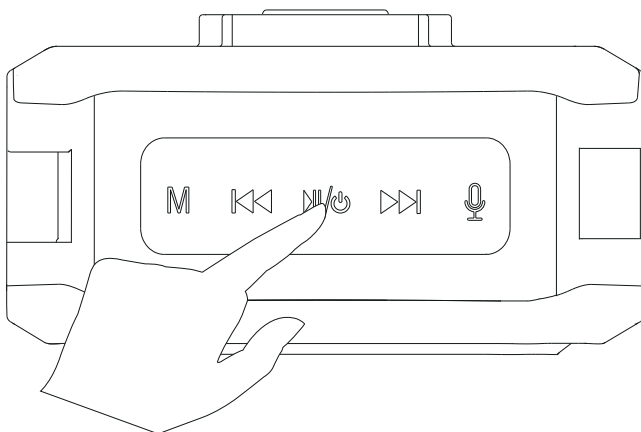



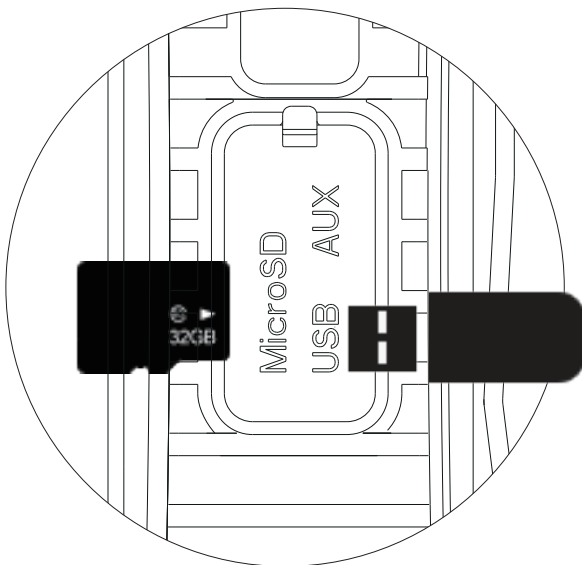

2. Music play via TF card / USB driver

Insert TF card / USB driver into corresponding slot, speaker will play music automatically; Press " ⏪ ", " ⏩ " to previous or next song

Noted: TF card or USB driver is NOT included;



3. How to play recording

1. Under any mode, press "  " key to start recording with voice prompts "start recording";
2. Plug headset microphone into MIC slot;
3. Click "  " button to finish and save recording; At this point, speaker will play recording file automatically you just made; Please click "  " button to pause or resume; Click "  " button to play previous or next recording file; Click "  " button again to play USB driver or TF card music;

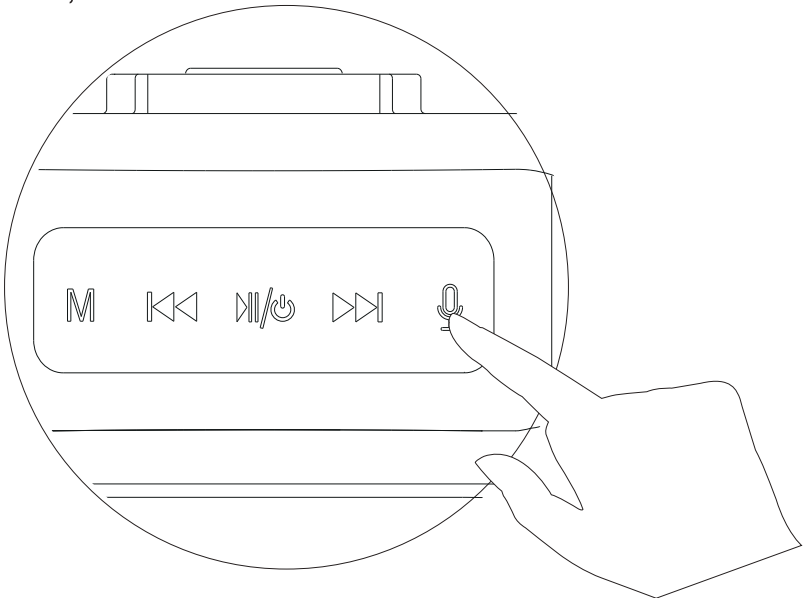

4. Click M button to quit recording and switch to other modes;
- Noted:** require a USB driver or TF card for storage and microphone for voice input;

4. Loop

In the MP3 playing mode, press and hold " M " key 3s to single song loop; press and hold " M " key 3s again for all loop.

Notes:

Speaker will be " all loop " by default after powered on next time.

5. Music play via AUX input

Connect speaker to external audio device (with 3.5mm audio output like computer) via audio cable included;

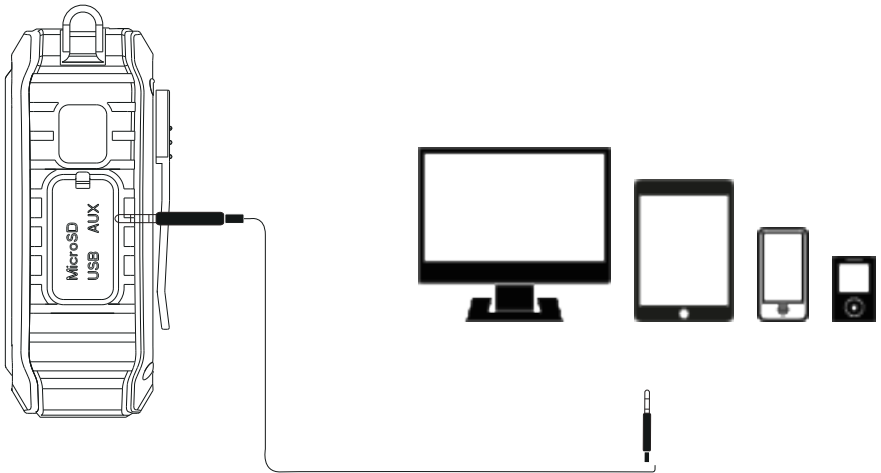

Speaker will play music with LCD screen shows "LINE" ;



5. How to connect with Bluetooth

1. Click "M" to switch to Bluetooth mode with a screen shows , and there will be voice prompts: Bluetooth is waiting for connection;



Turn on Bluetooth device and search name "M800" to pair.

7. How to charger speaker

Please turn the speaker off and charge it timely when it' s low battrey with voic prompt "Low battery, please charge". Please charge through Micro–USB cable with DC 5V output adaptoe.

Notes:

All functions will stop when charging;

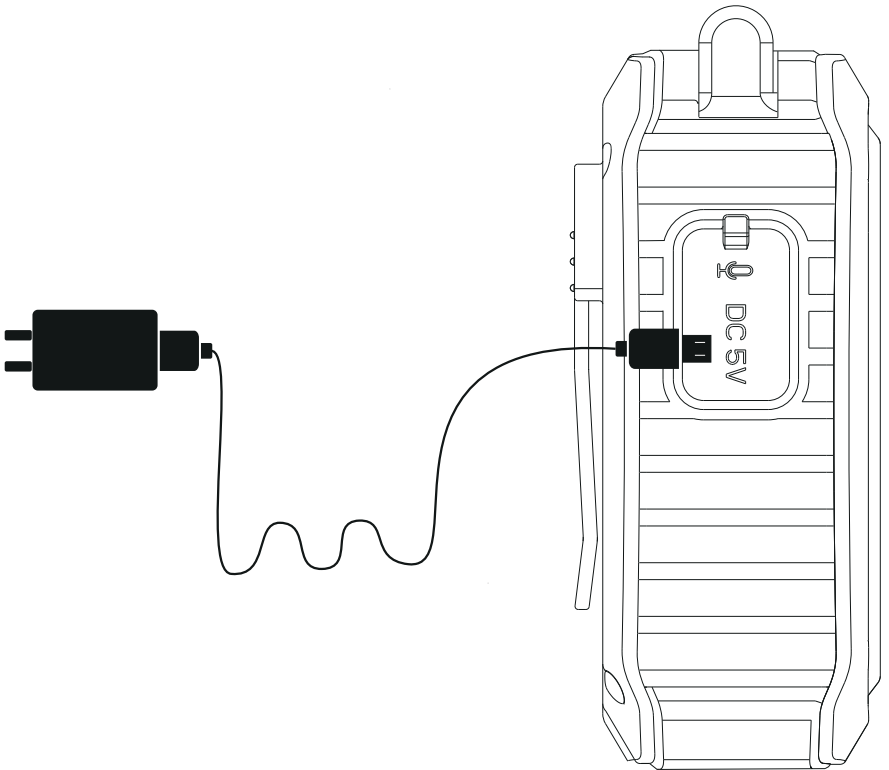

Please note:

1. Use the included DC 5V power adapter to charge the speaker internal rechargeable battery.
2. Plug adapter into 110~240 AC outlet. Connect the cable end into the DC 5V power input on speaker.
3. It will normally take 3–5 hours to fully charge the battery.
4. When charging is required, a voice prompt will indicate, " Low battery, please charge " , the battery indicator will blink while charging. It will stop blinking when battery is fully charged.
5. Recharge the battery within 48 hours of " low battery " voice prompt. In order to extend the life of the internal battery, please charge it regularly even if system is not being used.
6. It is suggested that you charge the internal battery an additional 1–2 hours after fully charged to extend its life.
7. Please DO NOT over charge the battery by leaving the system plugged in continuously. This will reduce the life of the internal rechargeable battery and could cause over heating.

Specifications

Max output power: peak 18W	Charging voltage:DC 5V 1A
Frequency response: 80Hz–18KHz	Amplify time: 8–10 hours
Output Impedance: 4 Ω	Music–play time: 8–10 hours
Work temperature: -10°C-45°C	Charging time: 3–5 hours

Package included:

- 1* speaker
- 1* headset microphone
- 1* waistband
- 1* DC 5V adapter
- 1* charging cable
- 1* audio cable
- 1* user manual

How to wear voice amplifier unit:

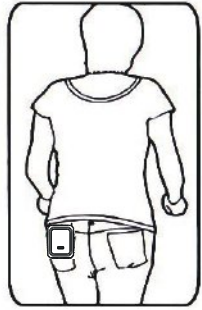
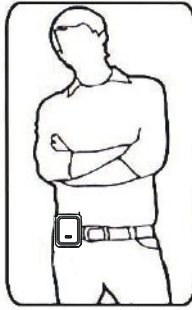
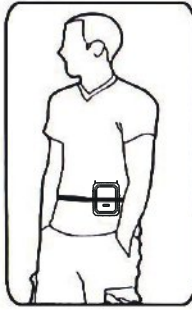
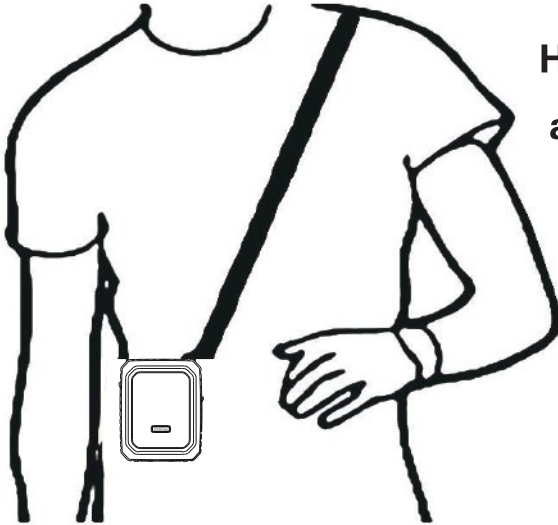



After-sale service

WinBridge provides one year warranty and lifetime technical support.



info@winbridgepower.com

<http://www.winbridgepower.com>



Please be confident that seller support is just a mail away from you in case you find any difficulty. Kindly do not hesitate to write back to us if you need any clarification or any kind of support.